

Some hypothesis to derive an anti-Einstein field

反アインシュタイン場仮説

Shunji Mitsuyoshi

Project Associate Professor, the University of Tokyo

Yuichi Tei

Professor, the University of Tokyo

Kosuke Tomonaga

Collaborative Researcher, the University of Tokyo

Tadao Nakamura

Emeritus Professor, Tohoku University

Masatsugu Hashimoto

Visiting Professor, Digital Hollywood University,
Graduated School

Abstract The theory of relativity by Einstein ^{[1][2]} can be interpreted by using a stereographic projection of points on the two-dimensional complex plane onto a three-dimensional sphere ^[3]. Especially, $1/0 = \infty$ is interpreted smoothly, which means that if an infinite point extends infinitely, the infinite point on the Riemann sphere ^[4] overlaps on the north pole. However, is this not simply saying that "infinite action is infinite"? This motif is the trigger for thinking of anti-Riemann geometric execution circumstances using a converse/inverse-Riemann sphere. So, we define and use "converse", "inverse" and "anti" as logic. Then we use this logic to derive an anti-Einstein field with a new operation ^[4]. As a result, when anti-0 $[0 \Rightarrow 1]$ is an emergence symbol, the Mitsuyoshi operator ^[4] uses a function as a simple means of connecting quantum theory and relativity and we hypothesize that $(0 \equiv \infty) = 1$. As a result, when anti-0 $[0 \Rightarrow 1]$ is an emergence symbol, we are led to the hypothesis that $(0 = \infty) = 1$ by using the Mitsuyoshi operator ^[4] as a simple means of connecting quantum theory and relativity.

Keywords: Theory of relativity, Riemann sphere, Quantum theory, Pair production, Klein bottle, Spontaneous symmetry breaking, Mitsuyoshi operator

1. Introduction

The theory of everything (TOE) ^[6] does not exist at the moment, which means there is no theory that explains the quantum theory ^{[7][8]} and the general relativity ^[2] simultaneously. On the other hand, in general, the behavior of gravity around the zero center ($m/0$) where the mass m divided by the radius $r = 0$ is understood based on the Schwarzschild metric that is the solution to the Einstein field equations. But the zero center per se is unexplainable with the concept of Einstein. The concept of zero distance as a physical quantity is often considered to be non-existent so that any unit less than the smallest unit of time and space (most likely approximately equivalent to Planck length) is not existing.

Reviewing the above general solution, we calculate the zero distance with Mitsuyoshi operator by compressing the diameter of the Riemann sphere from 0 to ∞ . The calculation results a new axiom of $(0 \equiv \infty) = 1$ and demonstrates the structure of the universe as viewed from outside the universe. Thus, we demonstrate that the Mitsuyoshi operator connects both quantum theory and Einstein field without contradictions by controlling "space-time" and the whole universe has a structure of $(0 \equiv \infty) = 1$, which indicates the structure when we observe the universe from outside the universe. Moreover, it indicates the possibility that the existence outside the universe was because of the emergence symbol anti-0.

We know the phenomenon that is called "spontaneous symmetry breaking" ^[9] proposed by Yoichiro Nambu in 1961. In the Nambu's theory, it has been confirmed that a physical system in a symmetric energetically stable state transitions to an asymmetric energetically lower state. And we also know the phenomenon that is called "pair production", which was predicted by Paul Adrien Maurice Dirac in 1930 based on

negative energy solutions of the Dirac equation ^[10], and was proved in "discovery of electronic pair production" ^[11] of Carl David Anderson in 1932.

On the basis of these two phenomena, we propose a hypothesis built up on the Klein bottle ^[12] to approach the TOE. In the Klein's bottle, the relationship between back and front is reversed in two dimensions at the neck of the bottle. Therefore, we focus on the neck of the Klein's bottle and consider the relationship between the neck and the front/back surface as follows.

A: Is there a twist like the Mobius loop at the neck?

B: Is there an effect of an inversion formula at the neck?

We can solve these problems simultaneously if we define the inversion formula of the problem B. First, we defined ^[13] the "Anti" as combination of converse and inverse such as the relationship between matter and anti-matter. Next, we use a novel operator ^[5] in order to connect converse and inverse. Therefore, we assume the inversion formula as a new symmetric system, in which an empty set and an ∞ were corresponding to an anti-empty and an anti- ∞ respectively, like the pair production.

In this symmetric system, we assume "emergence" to be a phenomenon, in which a symmetric energetically stable vacuum which is caused by a pair formation of "empty set: anti-empty set" moves to a symmetric energetically lower system. Here we assume that a stable vacuum ends up in a symmetric state in the anti-Einstein field to conserve total energy of all things although it ends up in an asymmetric state in the Einstein field. And we find that the pair production formula is essentially the same as positional numeral systems (N-ary) if we define an emergence symbol which generates 1 from 0 and we consider the generated 1 as the presence of all things based on the positional numeral systems as the concept of numbers.

On the other hand, we explain the double-slit experiment by using the new operator ^[5] which is applied to the inversion formula of the problem B as the positional numeral systems are the concepts to count things for human beings. In this hypothesis process, we first assume anti-Riemann sphere as

the nested model with the inverse-Riemann sphere and the converse-Riemann sphere as the geometric model. At this time, in order to mathematically confine "inverse and reverse" in one field, we connect the two spheres by the same new operator.

2. Anti-Riemann field

The Einstein field is the limited physical range under the Riemann sphere condition (Riemann field), and the anti-Einstein field is the limited physical range under the anti-Riemann condition (anti-Riemann field). "On the Riemann sphere (Einstein field), division by zero yielding ∞ ($1/0 = \infty$) is

explained by the projection using a sphere and lines, but how is the projection?" This question has not been answered after a long time.

First, we consider that the following figure which shows the relationship between matter and antimatter as an "anti" relationship (see Table 1), where the "anti" of A is anti-A.

Table 1: Comparative expression and mathematical interpretation

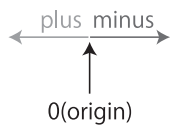
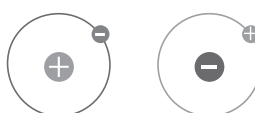
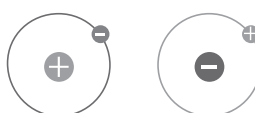
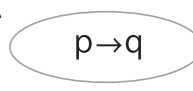
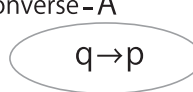
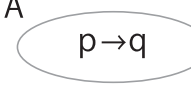
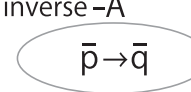
positive	negative	anti	converse	inverse
+A	-A	A : anti-A	A : converse-A	A : inverse-A
		Inversion of attributes in the same structure A anti-A 	reversing properties $(p \rightarrow q) - (q \rightarrow p)$ A  converse-A 	conditional negation $(p \rightarrow q) - (\bar{p} \rightarrow \bar{q})$ A  inverse-A 
		converse * inverse		

Thus, we avoid the confusion between expressions such as "anti" as represented by the relationship between "matter and antimatter" (anti meaning that the quantity and motion are exactly the same, but the composing elements have exactly the opposite characteristics), "converse" (the

opposite location or state without going through the origin), and the concept of a coordinate-like minus (negative).

In the figure 1, this characteristic is illustrated in colors (blue and red).

Figure 1: A and anti-A

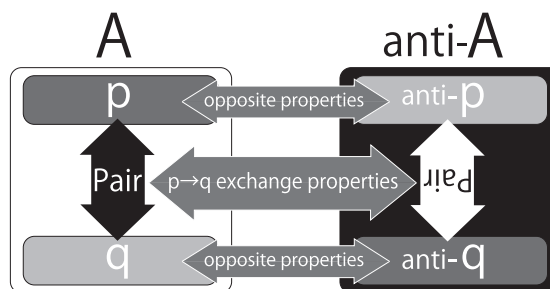

These can easily be represented using a magnet model, by reversing the attributes of N and S magnetic poles in Figure 2.

Figure 2: Magnet and anti-magnet

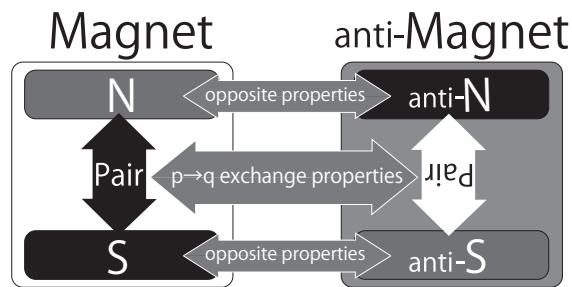

Here, if the space of a Riemann sphere is considered the Riemann field, then the anti-Riemann field would be this.

Figure 3: Exchange of polar characteristics of Riemann sphere and Converse-Riemann sphere



Here, the Riemann sphere becomes its converse, as in Figure 4, and so the converse-z plane is the anti-north pole in the converse-Riemann sphere, as in Figure 4.

Figure 4: Relationship diagram of the sphere by passing through the origin

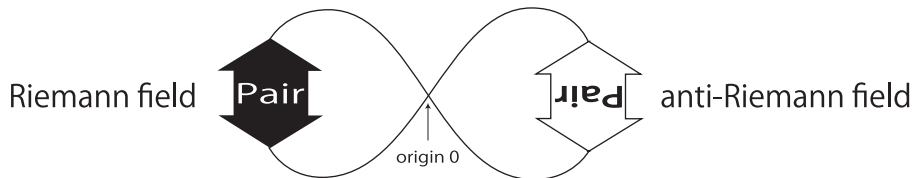

Using a diagram with the origin (0) as a baseline and placing the converse-Riemann sphere directly below the south pole, which is the origin, result in a converse mapping

from the polarity characteristic (color) through the origin, as shown in Figure 5. The result is a converse-Riemann sphere with the anti-south pole as the origin, as shown in Figure 5.

Figure 5: Riemann and converse-Riemann sphere

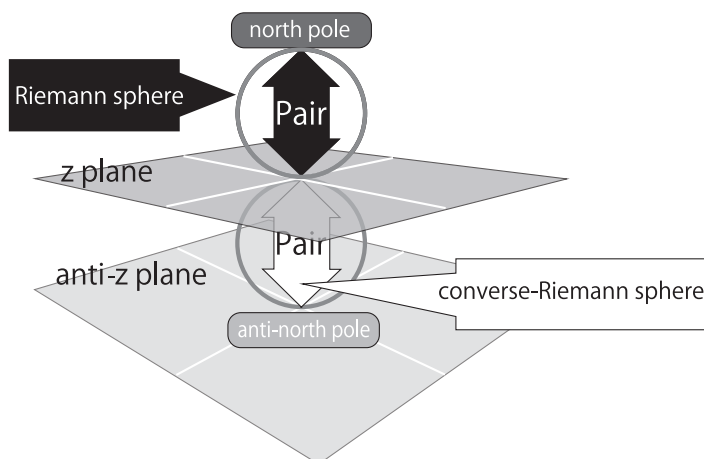

3. Converse-Riemann sphere model

In order to consider the converse of the Riemann, let us consider a sphere of diameter 1 with opposite polar properties that attach at the origin (0), as in the relationship between "matter and antimatter." Thus, we do not call it -1 . Instead, we call this sphere the converse-Riemann sphere.

The point where the converse-Riemann sphere touches the origin is the anti-south pole. Now, draw a line from infinity as

before to the anti-north pole (A), and let some arbitrary point from the anti-north pole (A) be the converse-z point. Since we cannot change the two-dimensional z plane into the converse-z plane, we reverse the polar properties and project the converse-z plane into the anti-north pole A, which corresponds to the z plane and south pole in the Riemann case (see Figure 6). This can be called a transition of the macro phase on the z plane to the converse-z plane.

Figure 6: Converse-Riemann sphere

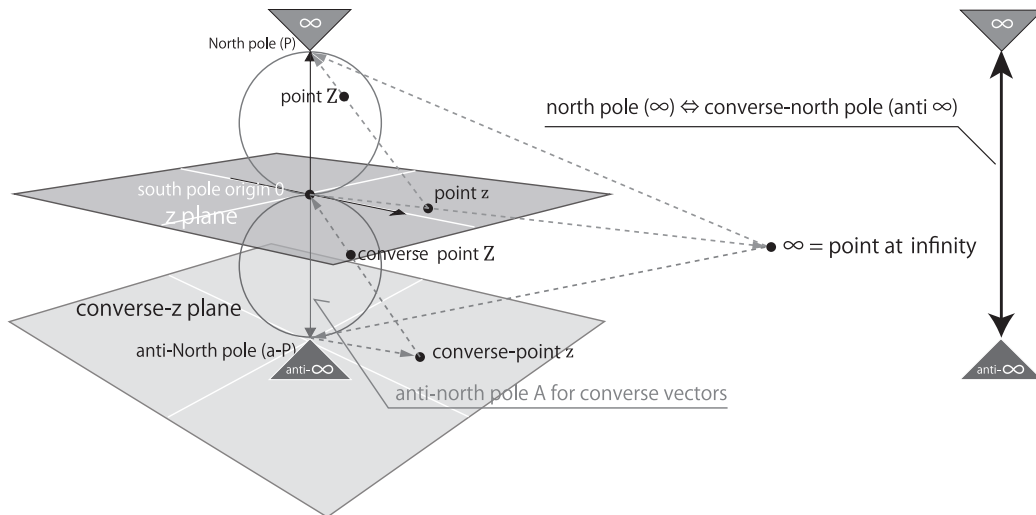

Considering $1/0$ in this converse-Riemann sphere:

First, on the top of the complex plane (z plane), let there be a sphere of diameter 1 that touches the plane at the origin under the Riemann sphere. This sphere is called the converse-Riemann sphere or the complex sphere. The upper pole of contact (called the anti-south pole) on the converse-Riemann sphere contacts the origin (0), and the point farthest from the origin (0) is called the lower pole anti-P (anti-north pole). By drawing a straight line from anti-P to any point on the complex plane (anti-z plane), and determining the point of intersection between that line and the surface of the sphere, this indicates the anti-Z on the sphere with respect to the complex number z on the anti-z plane.

From this, it can be determined that there is a one-to-one correspondence between the points on the converse-

Riemann sphere and the points on the anti-z plane. Thus, as a complex number z on the anti-z plane goes to infinity ∞ (diverges), regardless of the orientation, the corresponding anti -Z on the converse-Riemann sphere converges to the anti-south pole, or in other words, to the z plane of the Riemann sphere. This is the same structure as the convergence of $1/0$ on the Riemann sphere to the north pole, but the convergence is to the z plane in the case of the converse-Riemann sphere. The fact that all anti-Z points on the complex sphere on diameters (1) where the anti-north pole contacts the origin (0) converge to the anti-south pole as z goes to infinity as in the Riemann sphere is considered a division by zero, and is interpreted as $1/0 = 0$. This means that there are two answers to the division by zero.

Figure 7: Division by zero in Converse-Riemann sphere

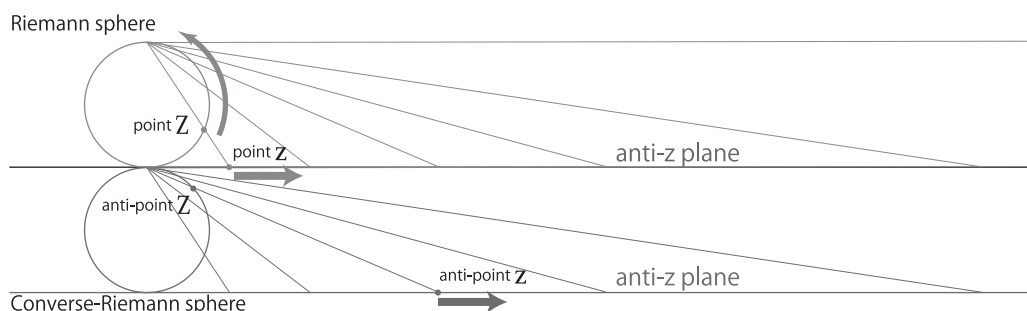

In addition, if we consider the anti-south pole on the converse-Riemann sphere to be the inverse of the z plane in the Riemann sphere (the plane corresponds to a point), then we can consider whether the interpretation of 0 (point) $\equiv \infty$ (infinity point in the complex plane), including

the correspondence of algebraic calculations of complex numbers to geometric operations on a Gaussian plane, is necessary for $1/0 = 0$ and $1/0 = \infty$ to hold in the Riemann and converse-Riemann spheres.

Figure 8: Converse-Riemann and inverse-Riemann

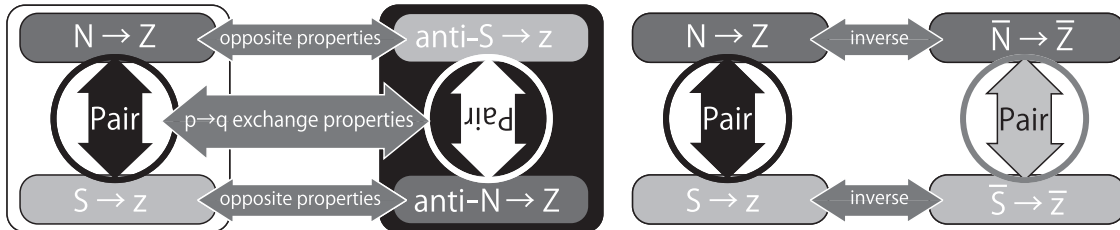

4. Inverse-Riemann sphere model

When considering what an inverse is, generally there are the following comparative expressions and numeric interpretations. "Anti" is a relationship between a substance and an anti-substance, whereas a converse is the functional reverse according to $(p \rightarrow q) - (q \rightarrow p)$, and with its anti-state as the functional-characteristic reverse of an anti-substance, the converse-Riemann sphere was considered to yield $1/0 = 0$. Here, we envision the inverse-Riemann sphere from the conditional negation $(p \rightarrow q) - (\bar{p} \rightarrow \bar{q})$ yielding the inverse. Compared to the case of the Riemann field and the anti-

Riemann field, the inverse-Riemann field from the inverse relation is shown in the Figure 8.

Here, although \bar{N} is not the north pole, there is still a question of whether it is the south pole, and whether \bar{S} is the north pole. In the case of the Riemann sphere, the debate concerns the surface of the sphere, and so \bar{N} becomes the north pole with an inward-facing vector that is not the sphere surface, and \bar{S} becomes the south pole that is not the sphere surface. As a result, points \bar{z} and \bar{Z} on the plane of inward-facing vectors of the Riemann sphere become the arguments of the inverse-Riemann sphere.

Figure 9: Inverse-Riemann sphere nested model-1

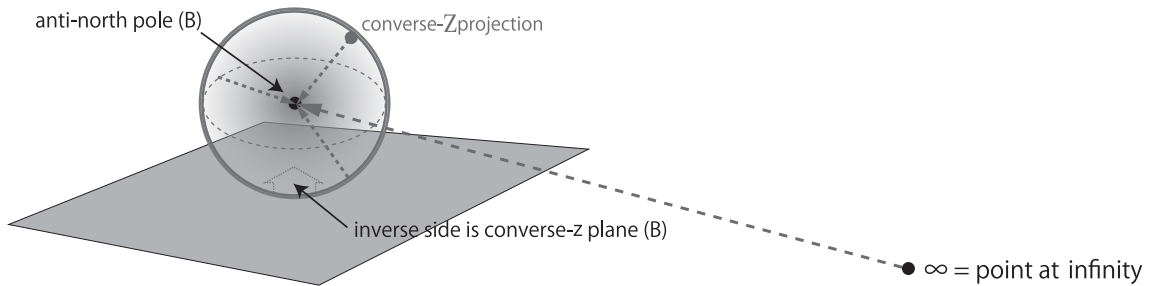

Meanwhile, for the Riemann sphere, since if $\{(\text{origin} \rightarrow z \text{ plane}) - (\text{origin} \rightarrow \bar{z} \text{ plane})\}$, only a sphere exists outside of the origin, we can consider the location of the anti-south pole by setting $\{(\text{origin} \rightarrow \bar{z} \text{ plane}) = (\text{sphere} \rightarrow \text{anti-z plane})\}$. Then, the anti-south pole is considered the entire inverse side of the sphere, and the anti-north pole, which is the farthest point, is located in the center of the sphere. This is equivalent to the case when the converse-Riemann sphere is thought of as being nested. Therefore, as the converse-z point overlaps with the crossing point with the plane (B), it becomes a transition where converse-z and converse-Z overlap

simultaneously (a quantum becoming a particle), and the z plane becomes nested inside the sphere as the converse-z plane with micro properties, including the probability that the converse-z point can exist anywhere on the inverse side of the sphere of diameter 1 (uncertainty of a quantum wave). Therefore, converse-z is freely and infinitely generated within the range of 1 for the Riemann sphere and converse-Riemann sphere (B) (see Figures 9 and 10).

Figure 10: Inverse-Riemann sphere nested model-2

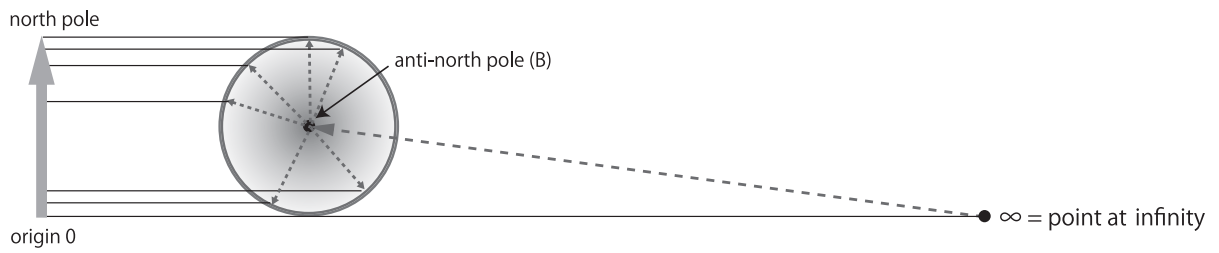

5. Converse-Riemann sphere nested structure mode

To the converse-Riemann sphere from the above, fit the inverse-Riemann sphere (see Figure 11).

Figure 11: Projection to converse-Riemann sphere

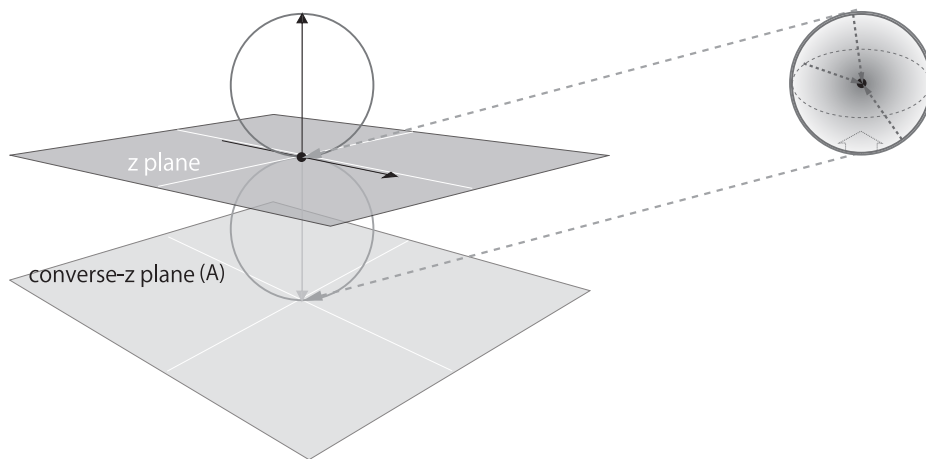

Then, the converse-z point and converse-Z point are freely and infinitely generated, overlapping simultaneously between the anti-north pole A and the origin, on the inverse side of the anti-Einstein field. Thus, nested converse-z planes exist

infinitely even in the anti- ∞ of the anti-north pole, and there is nesting from the north pole ∞ to the anti- ∞ in the anti-north pole (see Figure 12 and 13).

Figure 12: Anti-north Inverse of converse-Riemann sphere

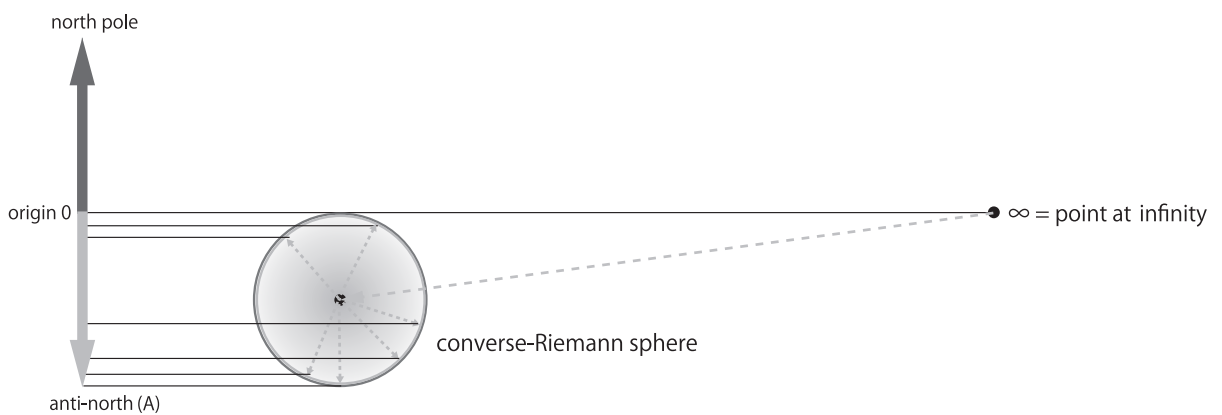

There have been a nested model based on the inverse of converse-Riemann sphere which the author proposed in a geometric model. However, in order to confine the inverse and converse-Riemann spheres mathematically into one field, it is

necessary to merge these two spheres by logical symbols. So, we present the hypothetical principle of anti-Einstein using the logical symbols proposed in my doctor thesis.

Figure 13: North \leftrightarrow anti-north Inverse of converse-Riemann sphere

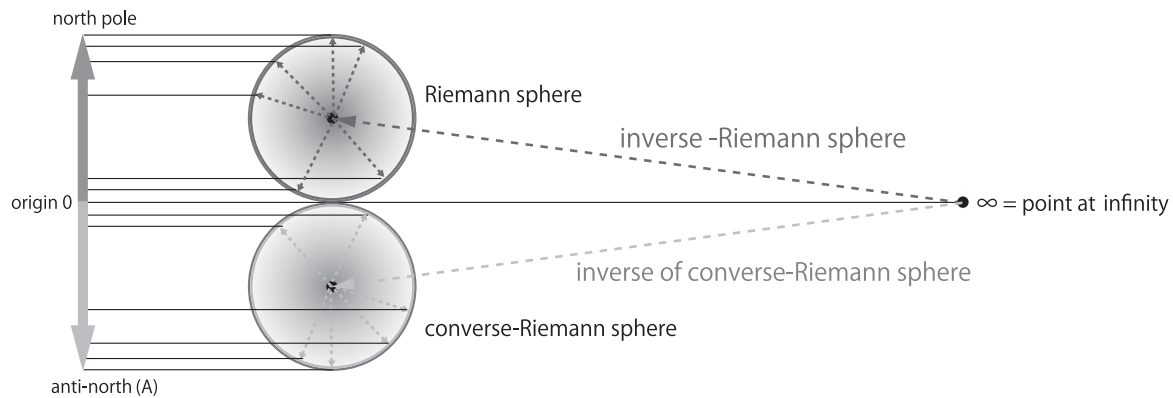

The figure 13 is the model concerning the Anti-Einstein hypothesis. In these three logical concepts "inverse" "converse" and "anti" are defined. Based on these definitions, the converse state and inverse state of Riemann sphere are unified against the geometric model using existing Riemann spheres. The state from the north pole of the Riemann sphere to the anti-North Pole of the converse-Riemann spheres is considered by nesting the inverse state in the converse state. However, this is a geometric approach, and has not reached mathematical models yet, that is to say, physics simulations or experimental proofs. "Anti" is a concept that brings the relationship between matter and antimatter to the concept of logic and mathematics.

However, in order to generalize this concept, the following work is necessary. For example, it is necessary to explain physical phenomena such as counter collision and pair-production by mathematical concepts such as zero (0) and ∞ , and to confirm the validity of "anti" by taking a method to obtain consistency. A new logic symbol will be necessary if required. It is expected that by taking these measures and working well with mathematical models, we can develop the concept into quantum effects and the Einstein theory represented by Riemann spheres. So, we introduce a mathematical simulation using new logic symbols and physical model.

6. Function of the new logical symbol (Mitsuyoshi operator)

Below, explains the logic symbols. Figure 14 shows a model that symbolizes the engineering functions of discrete quantities (such as concepts and thoughts) that are calculated at the same time as the continuous quantities of a gradation. This is a model in engineering that measures and calculates continuous and discrete quantities simultaneously. A and B are attribute symbols corresponding to concept and discrete numbers. x and y are physical quantities (such as

weight, length, and volume) corresponding to continuous numbers. The synchronized character of the slider should be noted here. To conduct the measurements and calculations of the corresponding continuous quantities simultaneously with the measurements and calculations of the discrete quantities, which serve as anchors, the symbolic slider must be synchronized. With this in mind, this symbol is designed to represent the slider motion in 2006.

Here, if the space of a Riemann sphere is considered the Riemann field, then the anti-Riemann field would be this.

Figure 14: Concept of the simultaneous calculation and computation of continuous and discrete quantities

Because the slider "moves" time is contained in the symbol, without using differentiation, complex natural phenomena can be made simple calculations.

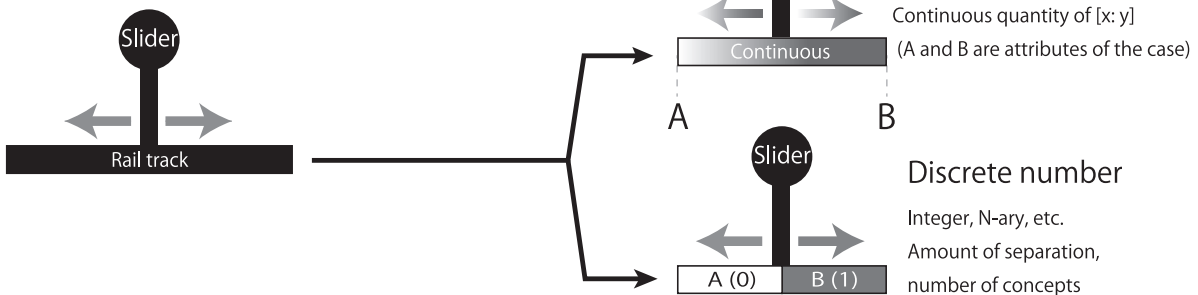

This is defined as a symbol for new operation instructions, and called the Mitsuyoshi operator. Though the meaning of the symbol itself is "motion between A and B" when used as a logic symbol or computational operator, as shown in Figure 14, it denotes a dynamic method of calculation that defines

a separation boundary between the continuous values of A and B separating them at a ratio of $x : y$. In contrast, other methods perform discrete calculations by transforming into conceptual numbers or symbols such as 0 and 1 by establishing a boundary that separates A and B.

Figure 15: Design of the symbol



6.1. Definition of the new logical symbol (Mitsuyoshi operator)

It is a dynamic method of calculation that defines a separation boundary between the continuous values of A and B separating them at a ratio of $x:y$, whereas the other method performs discrete calculations by transformation into conceptual numbers or symbols such as 0 and 1 by establishing a boundary that separates A and B. In addition, h is defined as the variable function that results from the variable functional property, f , which is derived from natural signal processing, resulting in $h = f(x)$.

The figure below shows how the anti-Einstein field is expressed with a "discrete conscious number" and "continuous matter quantity" using the Mitsuyoshi operator. (Mitsuyoshi operator was published in [1])

Traditional frameworks of computation have not established specific methods for the simultaneous calculation of concept numbers and continuous physical quantities. Thus, the mechanism of an engineering method is illustrated. Also, It is developed to conduct simultaneous calculations of continuous quantities, discrete quantities and slider synchronization (Table 2).

Table 2: Definition of Mitsuyoshi operator

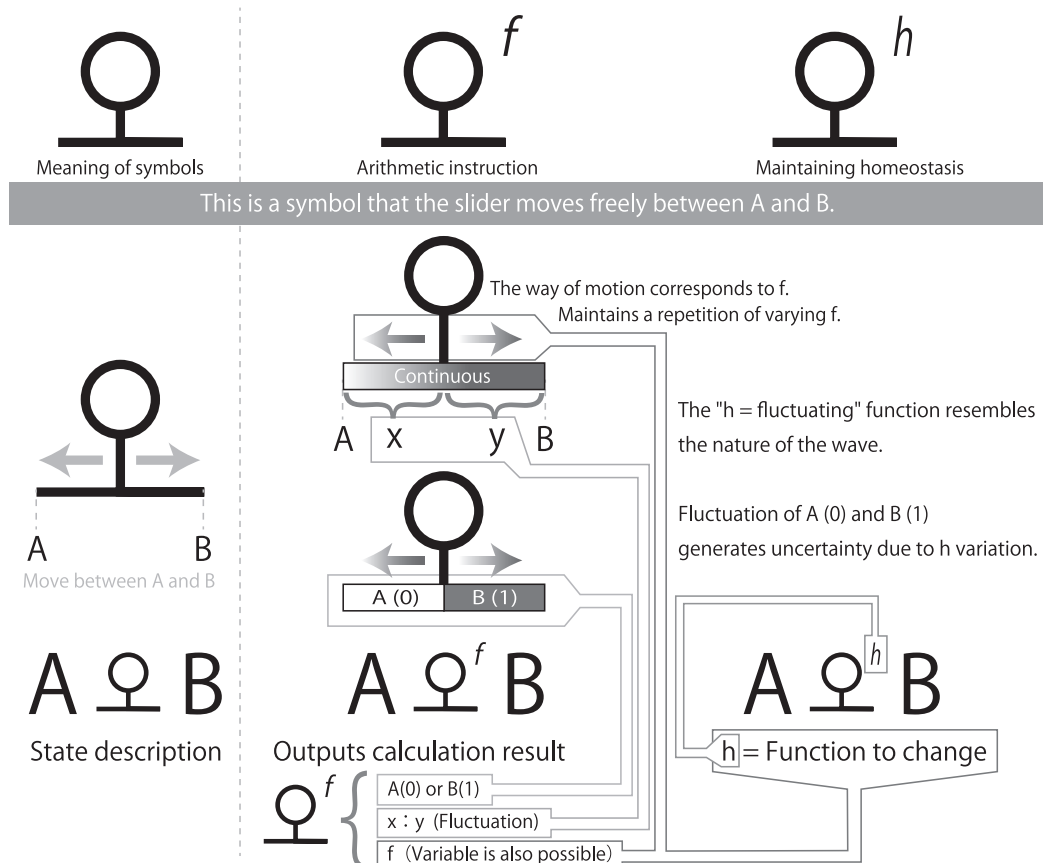

6.2. Specific method of computation for $A \oslash B$

If we substitute the computational symbol with a scale as an explanatory illustration (Figure 16), for weight (a physical quantity) as measured by the scale, x and y go onto the plates of the scale. Meanwhile, as conceptual symbols A and B correspond to the movement of the scale rod, the positions of the state, in which the weights of x and y are in contention, is defined as the metrical basis, where A and B are also in contention. Then, we determine the result of A or B by whether the rod leans towards A or B (in Figure 16 the quantity of y increased and the standard line lowered into the B area). Therefore, the result of the computation $A \oslash B$ gives the discrete result B from a continuous ratio of A and B ($x : y$). Thus, the calculations are normally executed through the simultaneous calculation of linear (analog) and discrete (digital) values, and is referred to as the non-Von Neumann computation

to distinguish it from traditional digital binary Neumann computations. Furthermore, with an understanding of the Feynman matrix vectors and Fourier transformations, in terms of the actual computation, the rail element of the operator can be thought of as a matrix and the slider as a vector. Thus, it can be easily determined that the vector means energy, leading to the rapid understanding of tensor fields. In the paradigm of scalar > vectors > tensors, we can comprehend the Mitsuyoshi transformation, which calculates energy fields using the transformation of tensors into vectors in a manner similar to that of Fourier transformations. In addition, within the framework of the computation methods derived from the Mitsuyoshi transformation (Figures 27-31), the dimensional relationship between the two operators of the slider vector and function set of the handle element can explain the phase transition resulting from passing through zero.

Figure 16: Engineering principle and output of the $A \oslash B$ computation

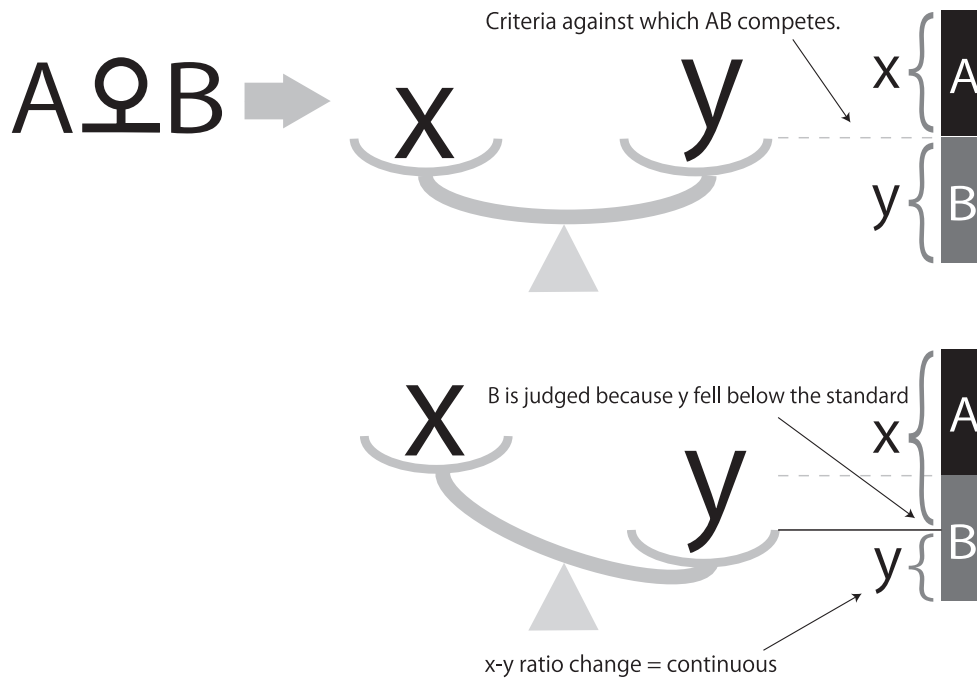

With a balance, the separated amount and the continuous amount can be expressed simultaneously.

6.3. Anti-Riemann field hypothesis using the Mitsuyoshi operator

Figure 17 illustrates a state in which the north and anti-north pole model are unified and the operator applied to the state between the north pole ∞ and anti-north pole ∞ , visually rendered as a Klein bottle. If the north pole (∞ in a

world comprised of matter) and anti-north pole (anti- ∞ in a world comprised of anti-matter) are unified with the Mitsuyoshi operator, a Klein bottle is formed. The figure below illustrates the parallel infinite simultaneous overlap and discrepancies in the converse z-plane.

Figure 17: Simultaneous overlap and discrepancy in anti-Riemann field

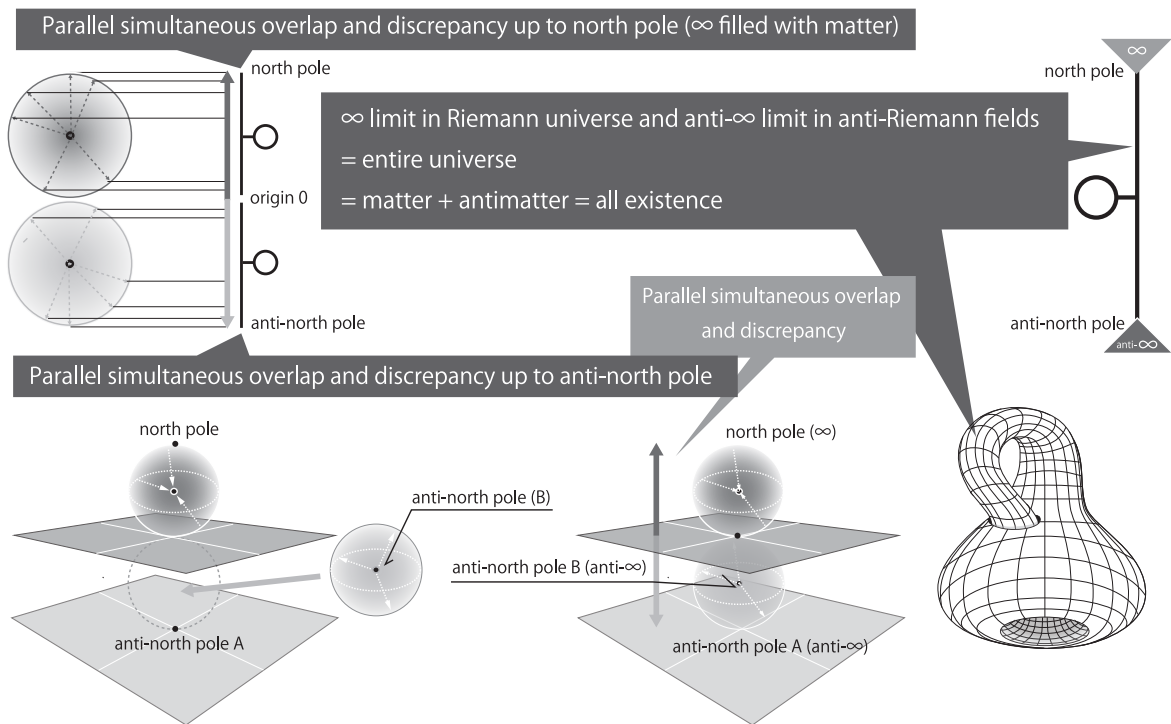

When thinking about anti-Einstein, considering generic physical phenomena such as quantum collisions or pair production, It may be obvious that the energy required for the effect of observation and phase transition in the "Schrodinger's cat" or "double-slit experiment," considering representative problems in quantum mechanics, could come from a "phase transition from equilibrium (a phase transition from equilibrium owing to a spontaneous breaking of symmetry)" from Youichiro Nambu and "pair production."

Suppose that by deriving the relationship for "observation

effect and matter," it is possible for matter energy to phase transition to "energy that includes any kind of diversity such as consciousness, some observation effect, or particle collisions," and to let the act of generating 1 (presence) from absence be anti-0, simply letting it be a symbol for emergent phase transition anti-0 = [0⇒1]. The state after anti-0 as the anti-Riemann field could be imaginable. Considering that 1/0 = ∞ and 0/1 = 0 in the Riemann field would have their 1 and 0 reversed in the anti-Riemann field (anti-Einstein field), they would become 0/1 = ∞ and 1/0 = 0.

Figure 18: anti- ∞ = [0 \equiv ∞]

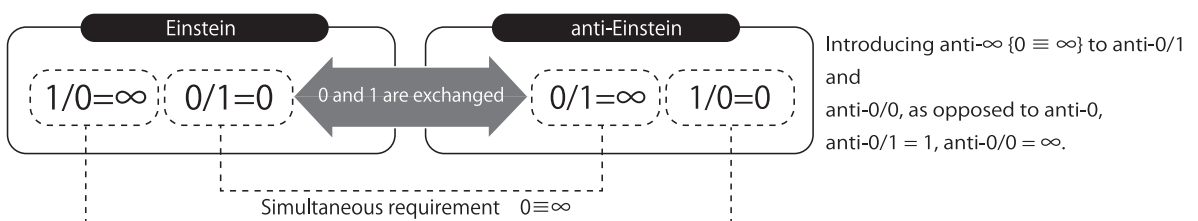

Thus, in imagining a transition from the Riemann field to the anti-Riemann field, simultaneous requirement $0 \equiv \infty$ for the gate from the Riemann field to the anti-Riemann field must exist in parallel to $\text{anti-}0 = [0 \Rightarrow 1]$. Let this be $\text{anti-}\infty = [0 \equiv \infty]$. Then, $\text{anti-}0/1$ becomes $1/1$ owing to $\text{anti-}0 = [0 \Rightarrow 1]$, and this is 1 in the Riemann field as well. In addition, $0/0$, which is not explained in the Riemann field, becomes $\text{anti-}0/0$ (that is, $1/0$) owing to $\text{anti-}0 = [0 \Rightarrow 1]$, and this is ∞ in the Riemann field.

Thus, the passing of the gate to $\text{anti-}0 = 1$ becomes possible. In addition, let $\infty + \text{anti-}\infty$, unexplained in the Riemann field, we turn to $\infty + \text{anti-}\infty$, which is the range of limiting ∞ ("range of all existence" in Figure 17), "the limiting macro." Now, if a vast amount of energy causes the vacuum to decay (as in "matter-antimatter collision" pair production, making the vacuum decay = letting something emerge), we convert division by zero in the Riemann field to this, and the author interprets for himself that this is the meeting (collision) of ∞ in the Riemann field and $\text{anti-}\infty$ in the anti-Riemann field.

Figure 19: The anti-Einstein hypothesis

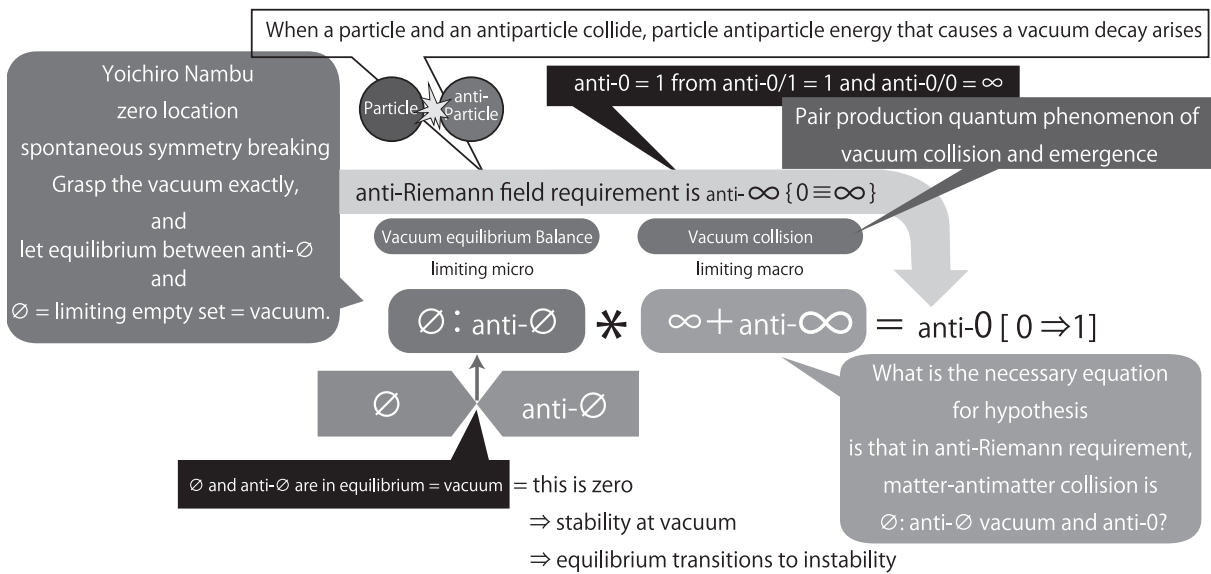

For this, Figure 19 illustrates the relationship through the "similarity of base- ∞ numbers and $\infty + \text{anti-}\infty$." With reference to Professor Nambu's theory, in the infinitesimal quantum world "limiting micro," the boundary between a positive (A) and negative (anti-A), fixed with balanced force, is a stable vacuum and a zero. Considering this vacuum to be the limiting empty set (Yoichiro Nambu has us imagine an equilibrium between positive and negative, but here, let the vacuum within the range of consciousness of the empty set be \emptyset , let the vacuum outside the range of consciousness be $\text{anti-}\emptyset$, and let their equilibrium state and ratios themselves be the perfect vacuum "limiting empty set"), its origin is considered the equilibrium between the empty set and the anti-empty set.

Equation 1: $\{\emptyset : \text{anti-}\emptyset\} * \{\infty + \text{anti-}\infty\} = \text{anti-}0$

Letting $[\emptyset : \text{anti-}\emptyset]$ be the ratio for the transition in the balance of ∞ and $\text{anti-}\infty$, and $\text{anti-}\emptyset = [\text{same property as the empty set but the property of membership is the opposite}]$, and considering an "empty set having infinite

range (macro)" whose possibility balance (like potential energy) of [properties in the empty set : properties in the anti-empty set] becomes zero, which is beyond "the empty set which is limiting micro," we can assume that the properties for "exclusion" are the opposite phenomena to properties for "inclusion," and imagine a mechanism in which the equilibrium transitions to such properties for "exclusion."

In addition, for ∞ and $\text{anti-}\infty$, if "anti- ∞ has the same properties (such as mass) as infinity, but the properties of the matter within it is the opposite," the energy needed for a unification with a limiting empty set state $[\emptyset : \text{anti-}\emptyset]$ can be interpreted as "matter and antimatter" and "pair production." This shows a mechanism for a transition from equilibrium to an unstable state. At this time, the concept of the number 1 as "presence" is first generated by passing through the limiting micro and macro, "nothing and ∞ ." Therefore, we can see the necessity of the equation 1 $[\emptyset : \text{anti-}\emptyset] * [\infty + \text{anti-}\infty] = \text{anti-}0$. In addition, it is worthwhile to consider in $*$ the relationships between $\text{anti-}\emptyset$ and ∞ , and between $\text{anti-}\infty$ and \emptyset .

7. Division by zero in an anti-Riemann field

Here, we will explain the geometric interpretation of anti-Riemann fields and division by zero are explained. Figure 20 renders $0 \equiv \infty$ into a visually intuitive diagram.

In Figure 20, above the operator to the left, $\lim_{n \rightarrow 0}$ is represented as quadrangles approaching 0. Conversely,

below the operator, $\lim_{n \rightarrow \infty}$ is represented as quadrangles with increasing size. Summarizing this as a characteristic that seals the time-independent quality of the operator, both above and below become the same nested structures, rendering an intuitive representation of $0 \equiv \infty$.

Figure 20: Geometric rendering of $0 \equiv \infty$

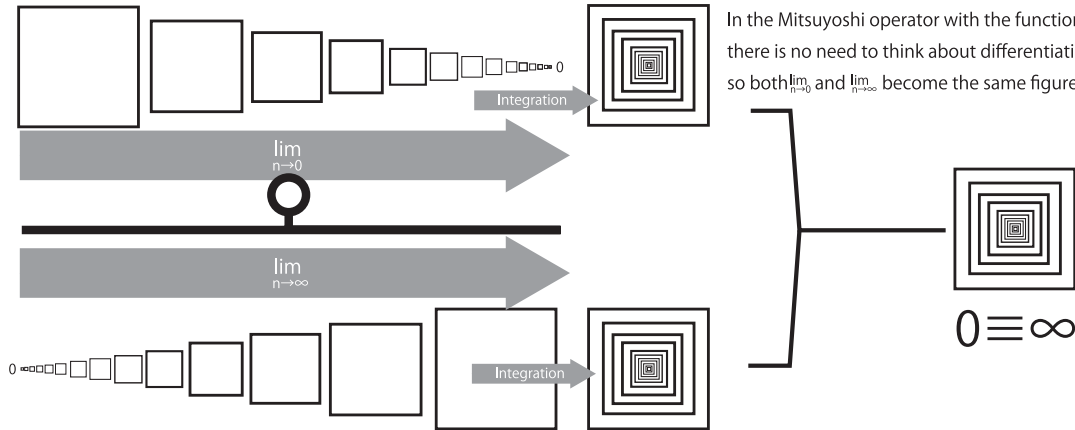

In the Mitsuyoshi operator with the function of moving, there is no need to think about differentiation and time, so both $\lim_{n \rightarrow 0}$ and $\lim_{n \rightarrow \infty}$ become the same figure.

Meanwhile, recognizing that $0 \equiv \infty = 1$ by first using anti-0 to represent a box, as shown in Figure 21, and comparing to 1 (that is anti-0) and $0 \equiv \infty$ as represented in Figure 20, it can be more clearly understood.

Figure 21: What is meant by $(0 \equiv \infty) = 1$?

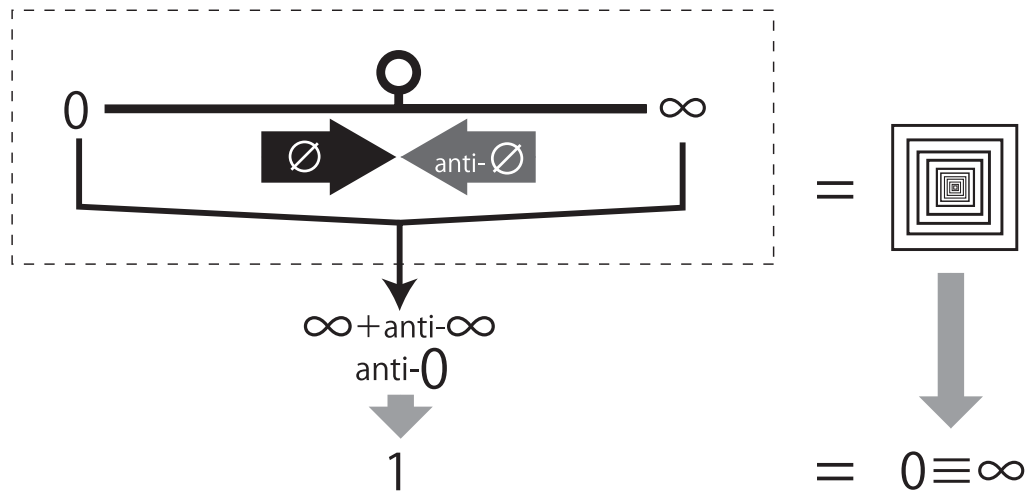

8. Explaining the effects of observation in quantum dilemmas

Next, if we visually render the observational effect on quantum dilemmas with the Mitsuyoshi operator, we obtain Figure 22, which illustrates a state analogous to an electron that is passing through a slit using the Mitsuyoshi operator.

If we place this state, where the null-set and anti-null set are in contention for the position of the slider in the Mitsuyoshi operator, it becomes an anti-0 point that gives rise to 1 (concept number). This leads to the possible explanation that this emergence causes the observed electron to become a particle, which then passes through the slit.

Figure 22: Effects of observation in quantum dilemmas as viewed through the Mitsuyoshi operator

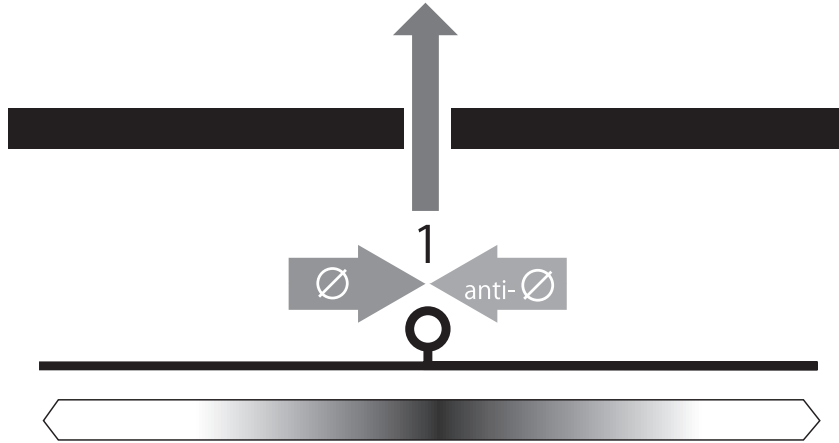

Furthermore, considering the elegant quantum thought experiment of the double-slit problem, if we remove the operator slide (representative of the concept depicted in Figure 22) as seen in Figure 23, the gradation model of the Mitsuyoshi operator bar can then be interpreted visually as the wave-form outcome of the double-slit experiment.

Figure 24 illustrates the same experiment observed through the state of Figure 22.

Figure 23: The double-slit problem as interpreted using the Mitsuyoshi operator (wave-form)

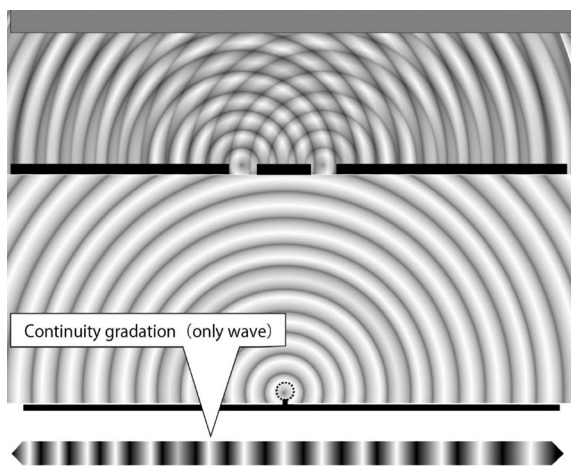
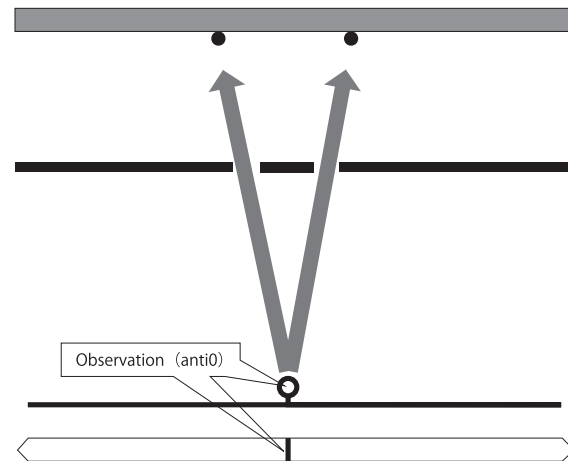

Figure 24: The double-slit problem as interpreted using the Mitsuyoshi operator (particle-form)



9. Explaining the effects of observation in quantum dilemmas

If we represent the anti-Einstein field as “discrete concepts” and “continuous matter” using the Mitsuyoshi operator, it becomes the following (Figure 25).

Figure 25: Anti-Einstein field interpretation model using Mitsuyoshi operator

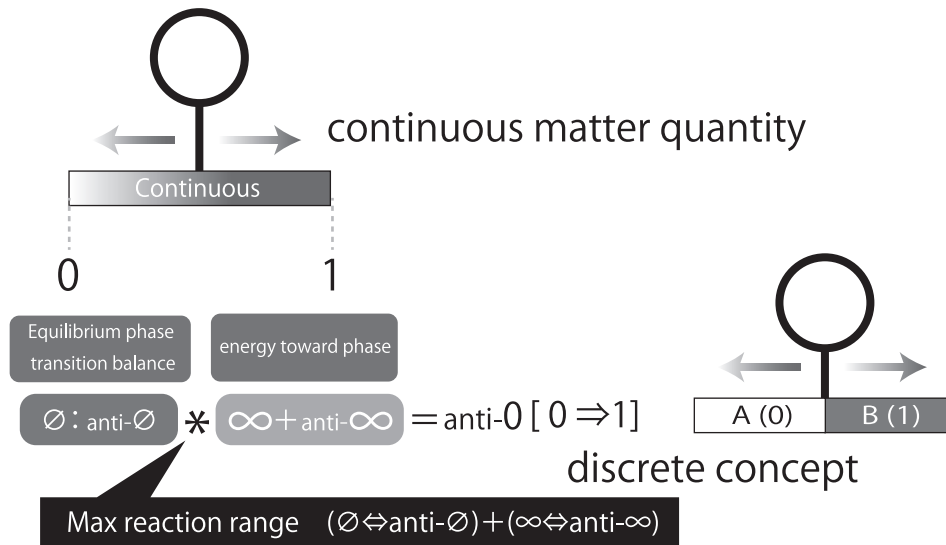

Figure 25 shows how the state of nested operators in Figure 26 is explained using the converse-Riemann sphere model in Figure 11. Anti-0, which is an anti-Riemann state, becomes a reaction between ($\emptyset : \text{anti-}\emptyset$) and ($\infty + \text{anti-}\infty$), and it means the infinite overlap of converse-z planes in the converse-Riemann sphere model, as in Figure 11. In addition, this is a figure that simulates what occurs to base-N numbers as a concept of “counting” in the limiting base- ∞ numbers in the anti-Riemann field, when the initially defined an emergence property that $0 \Rightarrow 1$ anti-0 is the emergence of 1 from nothing, and this 1 is grasped as the concept of “presence.” The overall structure of the figure is a resonant synchronization model, with the image of two pendulums synchronizing when one pendulum is embedded in the weight part of another pendulum. Anti-0 in Figures 19 has the structure that the reaction result of ($\emptyset : \text{anti-}\emptyset$) and ($\infty + \text{anti-}\infty$) is ($0 \equiv \infty$), and the range between ∞ and anti- ∞ owing to the north and anti-north poles is “all existence.”

On the other hand, 1, which is an anti-0 requirement, signifies the entire range of “all existence,” encompassing “all existence,” and quantitatively represents the abstract concept “all existence” = “all things exist.” Here, since we were able to define the range between ∞ and anti- ∞ from before, said to be “all existence,” as 1 (presence), the nesting loop is guaranteed. The important point here is that since the range between ∞ and anti- ∞ owing to the north

and anti-north poles has a nested structure, and corresponds to anti- ∞ (which is an anti-Riemann requirement), and we were able to define the range between ∞ and anti- ∞ from before (said to be “all existence”) as 1 (presence) by the initially defined emergence requirement anti-0, there is a unification of an abstract concept and a number by letting 1 in the initially defined emergence requirement anti-0 = 1 be “presence (all existence).”

This means that “the beginning of existence (all existence)” is 1, the concept of counting and “presence” correspond to each other, and within the range of this all existence (existence = 1), we can actually set the limiting base- ∞ number in the anti-Riemann field as $a_{\infty} N^{\infty} + a_{\text{anti-}\infty} N^{\text{anti-}\infty}$. With this, we can let the collision-generated energy (that makes the vacuum decay) of $\infty + \text{anti-}\infty$ be equivalent to the base- ∞ nothing in the limit of the anti-Riemann field. This makes ($0 \equiv \infty$) the anti-0 condition, as shown in Figure 19, for the passage of singularity that makes the presence emerge, and ($0 \equiv \infty$) = 1. It should be noted that 1 here is a concept that indicates all existence, and that it is the sum of ∞ and anti- ∞ ($1 = \infty + \text{anti-}\infty$). Since this may eventually be similar to the argument that “infinity is infinite” in the explanation for division by zero in the Riemann field, we claim that this only shows the possibility of being effective under the condition ($0 \equiv \infty$). However, under the condition of treating concepts as consciousness.

Equation 2: N -ary method * ∞ Coordinate (Concept·Thought) = $\{\infty + \text{anti-}\infty\} * \{\emptyset : \text{anti-}\emptyset\}$ (Timing vector·Energy)

Equation 3: (Concept·Thought) = (Timing vector·Energy)

Here, a final explanation of the Mitsuyoshi operator should be explained. The + symbol, for addition, is the operator for combining one object with another. The Mitsuyoshi operator is an operator for splitting an object. In addition, both simultaneous and discrete calculations are possible simultaneously, which saves time, and unlike division, the totals on the left and right sides of equations are maintained in strict adherence to the laws of thermodynamics; thus, it is a useful tool that is capable of including dynamic functions. It is true that the explanation in Chapter 2 by itself can be considered merely an explanation of a state. However, in that case, the addition operation would be merely an explanation of a combined state. This is the essence of operators. Therefore, unlike addition, it has not been possible to describe the conditions for division to equally balance the left and right sides of an equation. It is likely that because

the quantum theory breakthrough idea of simultaneous calculation of linear and non-linear forms of dynamic state calculations of discrete and continuous functions is difficult to comprehend, it was intentionally explained in a supplement. Naturally, there is no disputing that there are objections. The Mitsuyoshi calculation of A and B is a current dynamic state calculation, and so it does not result in a set answer. As a result, although it does not seem like an operator in a worldview in which time is stopped, once time is excluded, a function f is output as a dynamic regularity within a certain scope, and the quantum state is represented by x,y and the like, which will be understood as a new true meaning of calculation. This feature can be useful in calculating the emergence of a Grand Unified Theory for the professors at Stanford University, who are our research collaborators.

Figure 26: Space-time concept in anti-Einstein field

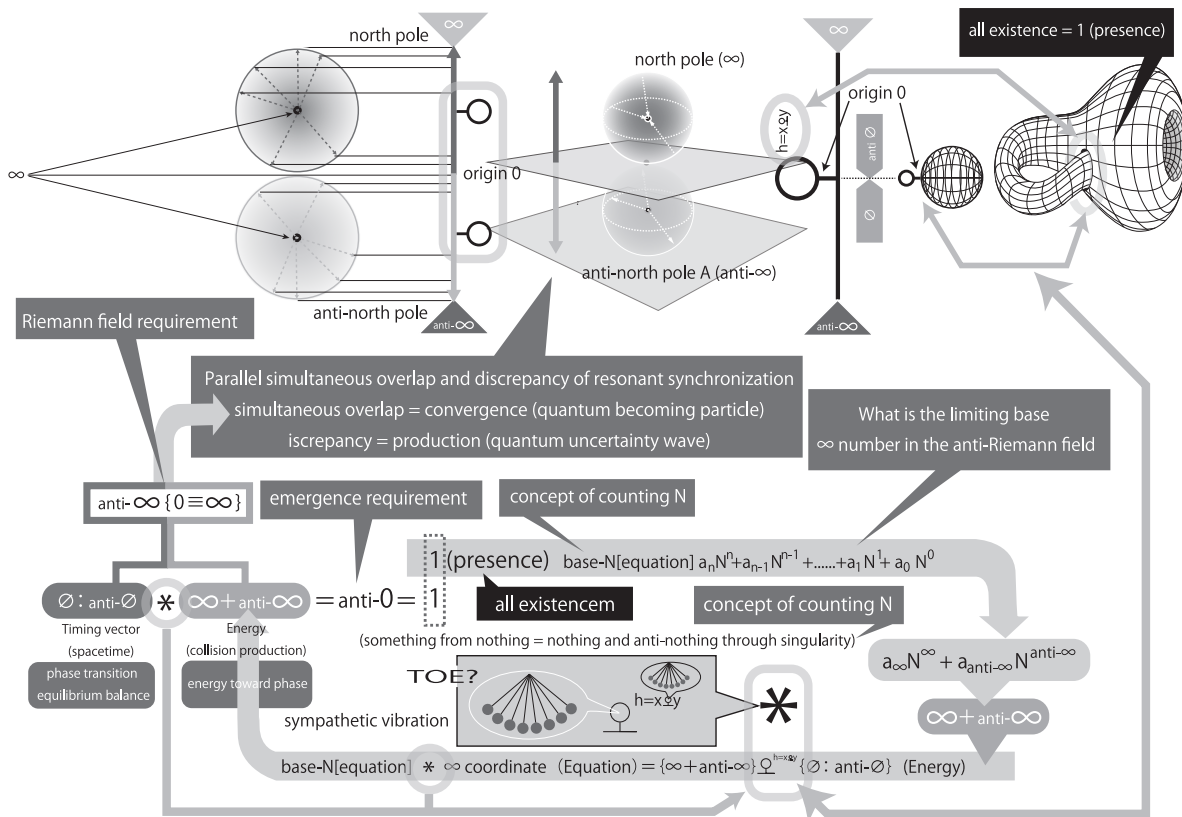

In Figure 24, it is stated that "it is worthwhile to consider in * the relationships between anti-∅ and ∞, and between anti-∞ and ∅," but in the above figure, we can imagine a "exchanging of nesting" functionality owing to {∞+anti-∞} Ω^{h=x*y} {∅: anti-∅} where x = (∞ · anti-∅) and y = (anti-∞ · ∅). The reason is that it is necessary to consider ∞ and "thing to be excluded," anti-∞ and "thing to be included," ∅ and "matter properties to be fulfilled," anti-∅ and "antimatter properties to be fulfilled," or ∅ and "matter properties to be fulfilled," and anti-∅ and "matter properties that are not fulfilled (with additional consideration for antimatter

properties)." In addition, as a potential, "to be excluded," "to be included," "to exist," "to be fulfilled," and "possibility that it is not fulfilled," are concepts that make the past, present, and future exist simultaneously. They negate the constraint of nature and tense.

Using Ω for the correlation between this potential and the Feynman energy in the very micro world, as well as "vector potential," important for the concept of momentum, letting it feedback from tense, and organizing the explanation by determining the definition of potential as a parameter, it would be an interesting future problem.

10. Anti-Einstein's mathematical model

In order to simplify the complicated exchange relations above, we consider symbols as in Figure 25 below. This is imagined as a combination of two Mitsuyoshi operators above and below, being a representation of competition and collision as one. The symbol design is such that the state is turned into a total sum such as Σ , difference such as Δ , and then condensation, as in emergence. The symbol, as an operator of "resonance expansion," combines as one the "exchange of the nesting" function on $(\infty + \text{anti-}\infty) * (\emptyset :$

$\text{anti-}\emptyset)$ owing to $x = (\infty \cdot \text{anti-}\emptyset)$ and $y = (\text{anti-}\infty \cdot \emptyset)$ as a contrapositive relation of " taking the converse then inverse of a statement. With this symbol, for the combination of $(\infty + \text{anti-}\infty) \Omega^h (\emptyset : \text{anti-}\emptyset)$ and $(\infty : \text{anti-}\infty) \Omega^h (\emptyset + \text{anti-}\emptyset)$, h in the head part of the lever (function set) results in the functions of the energy from condensation in the top layer and the emergence as dispersion (divergence) in the bottom layer through $x = (\infty \cdot \text{anti-}\emptyset)$ and $y = (\text{anti-}\infty \cdot \emptyset)$ and other free combinations.

Equation 4: $\text{anti-}0 = (\infty + \text{anti-}\infty) * (\emptyset : \text{anti-}\emptyset) \{x = (\infty \cdot \text{anti-}\emptyset), y = (\text{anti-}\infty \cdot \emptyset)\} = \text{海ウニ}$

Figure 27: Explanation of the orthogonal model for duality of zero (1)

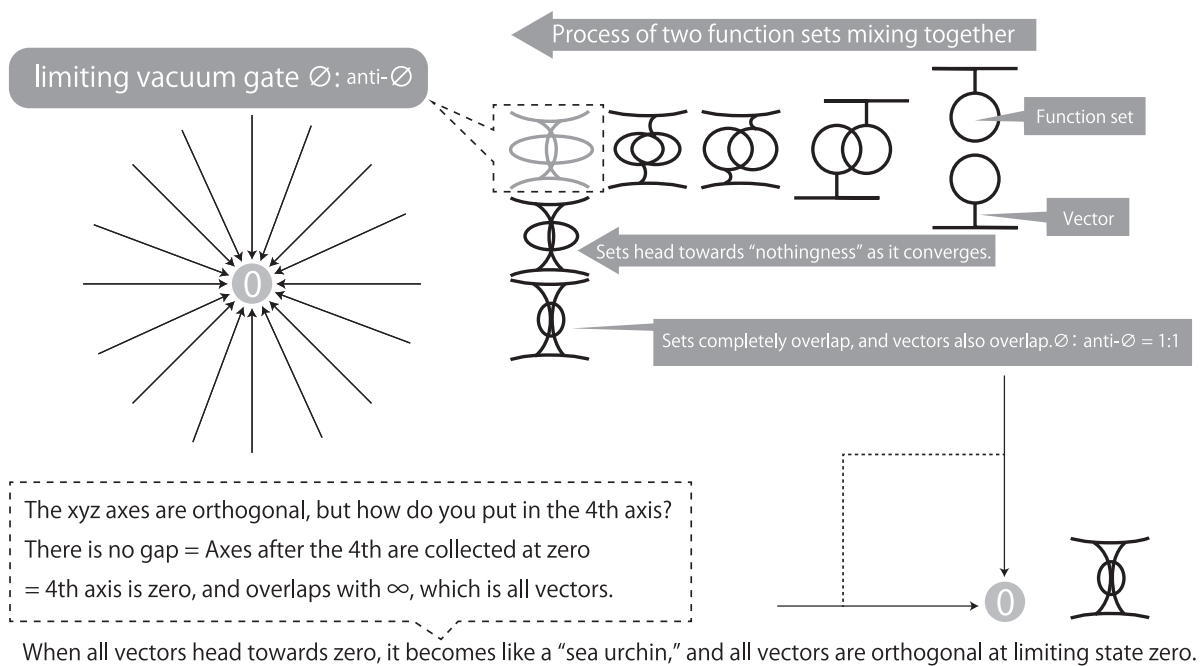

Here, we can see that the mechanism for the "duality of zero" in Figures 27-29 is the same as the mechanism for an emergence gate. We now explain the continuous state of 海ウニ . When all function sets head toward "nothingness" zero, converging like an infinite-dimensional

Lie group, all vectors are orthogonal at the limiting state of zero. They become like a "sea urchin," passing through zero as a vanishing point, and radiate outward, all still as orthogonal vectors.

Figure 28: Explanation of the orthogonal model for duality of zero (2)

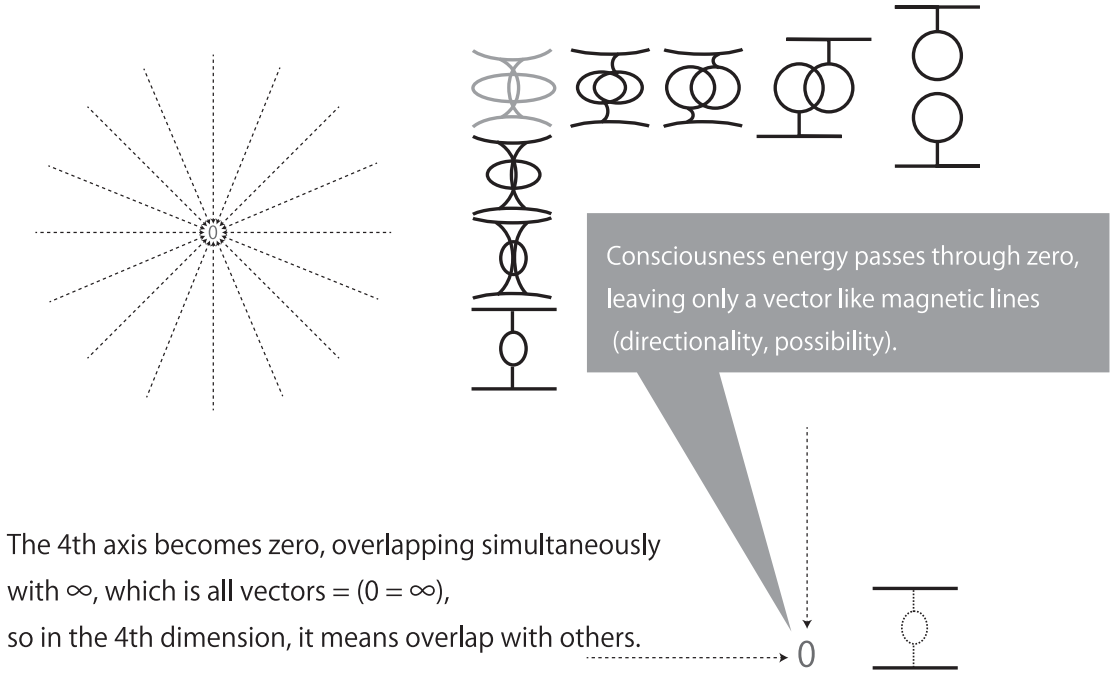

The 4th axis becomes zero, overlapping simultaneously with ∞ , which is all vectors = $(0 = \infty)$, so in the 4th dimension, it means overlap with others.

Figure 29: Explanation of the orthogonal model for duality of zero (3)

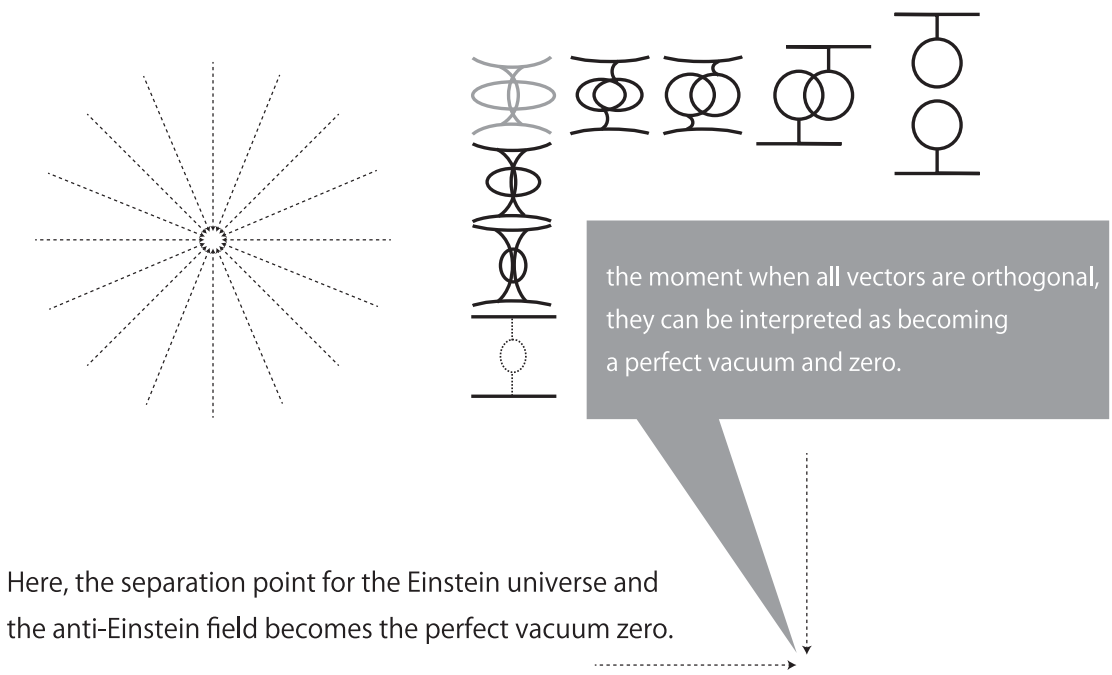

Here, the separation point for the Einstein universe and the anti-Einstein field becomes the perfect vacuum zero.

Thinking of 4 dimensions spatially, the x, y, z axes are orthogonal. Since there is no gap to insert the 4th axis there, vectors after the 4th axis are collected at zero,

as in Figure 28 and 29. The 4th axis becomes zero, overlapping with ∞ , which is all vectors. Thus, $0 \equiv \infty$, meaning overlap with others.

Figure 30: Explanation of the orthogonal model for duality of zero (4)

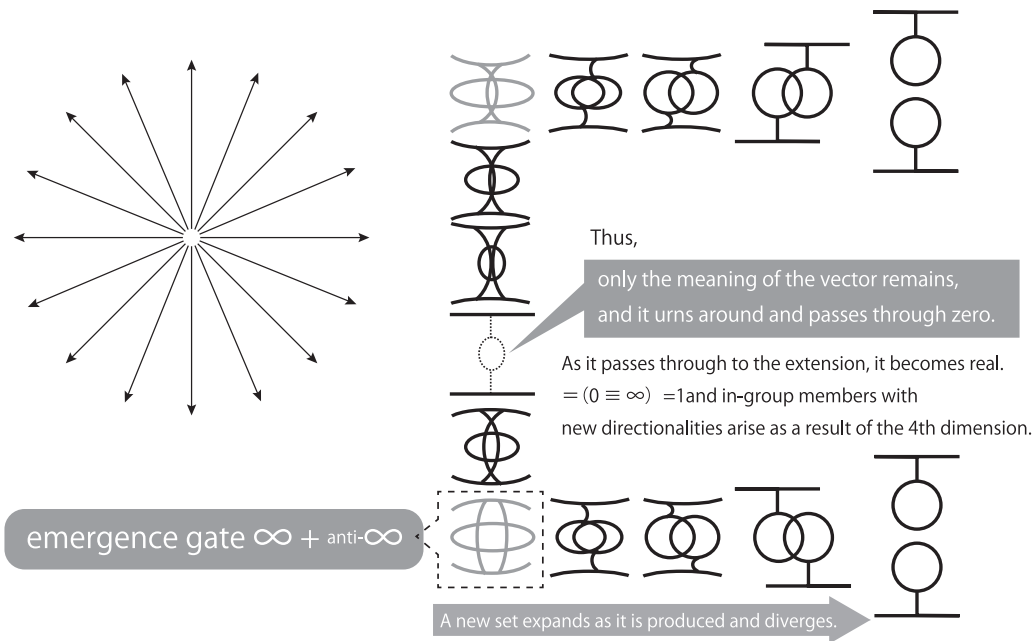

In this process, consciousness energy passes through zero, leaving only a vector like magnetic lines (directionality and possibility). In the human relation, this can be said to be the state of overlapping with the other and sharing the other's mind (vector). In other words, two function sets mix together and disappear, becoming just a vector.

Here, the separation point of the Einstein field and the anti-Einstein field becomes zero, and the field is separated as if digitally (conceptually). Meanwhile, at the moment all vectors are orthogonal, they can be interpreted as becoming a perfect vacuum and zero. Then, only the meaning of the remaining vector turns around and passes through zero, and as it passes through to the extension, it becomes real. This corresponds to the emergence of materialization from concepts with only quantities, passing through zero.

Once it becomes complete nothingness, the energy becomes real along the reversed vector, bearing fruit in the opposite direction. If this anti-Einstein is true, it may be possible in the future to implement a function (wave) as energy at the quantum level, as in Equation 4, and generate matter by figuring out a method to implement the converse of path's space in infinite-dimensional Lie groups, vector fields, or Riemann space, and performing the harmonic convergence emergence transition operator through function fusion owing to wave superposition and interference.

In addition, zero exists everywhere, and a concept ("awareness" or spirituality) means the realization (action) wherever it is from zero. Thus, this method as a theoretical physics interpretation can explain the micro quantum effects as a transition (emergence) gate to a macro phase, explaining the quantum world in a macro way. In addition, by interpreting magnetism and radiation as energy having only directionality, an explanation of black holes becomes easier. At the same time, this is a hint for consciousness emergence in robots. Thinking about this in terms of quantum numbers, for example, in a one-dimensional harmonic oscillator in an N-particle system, we can choose position or momentum (quantity), but we can also choose the number n (concept) in the energy eigenvalue E_n .

When the position or momentum is chosen as the quantum number, the quantum number is a continuous variable, but if the energy eigenvalue number is chosen, it becomes discrete. Now, by considering the one-dimensional harmonic oscillator as a Mitsuyoshi operator or harmonic convergence emergence transition operator, quantum theory can easily be explained. At the beginning of the field, baryons were generated from the initial condition having baryon number 0, yielding a field with a positive baryon number, but the details are unknown. This is also explainable by referring to Figure 31.

Figure 31: Design process of the harmonic convergence emergence transition operator

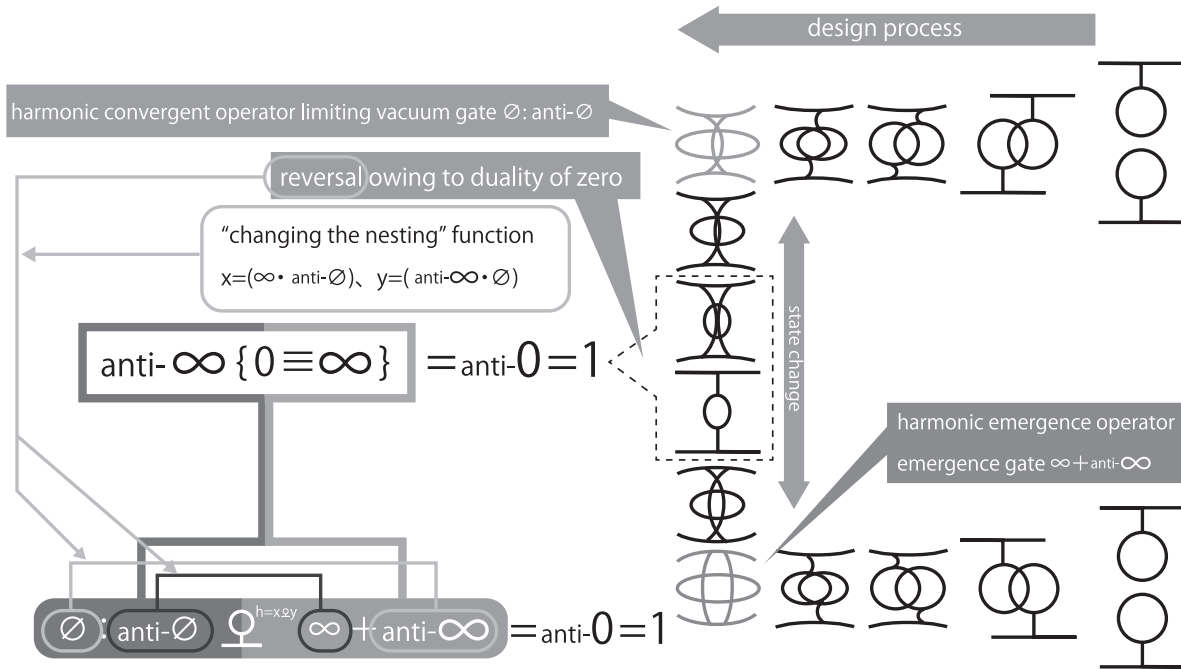

In the Figure32 shows the relationship between an Einstein field and an anti-Einstein field.

Figure 32: The relationship between an Einstein field and an anti-Einstein field

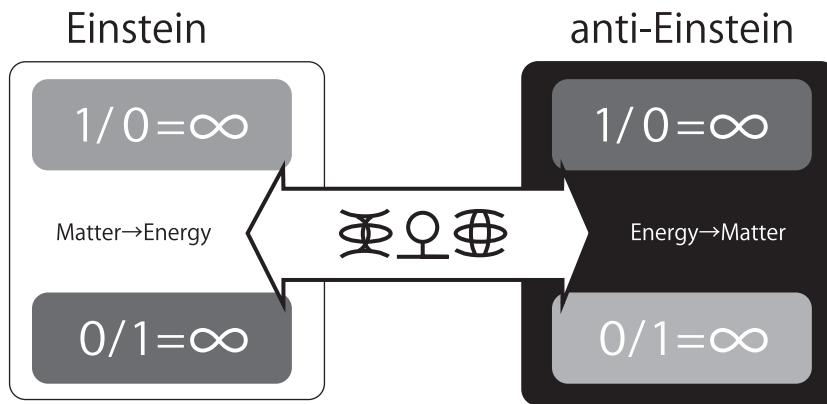

11. Conclusion

The Einstein's Theory of Relativity can be considered with a technical interpretation on the Riemann sphere where all points on a complex two-dimensional plane are stereographically projected onto a three-dimensional sphere. Such interpretation enables straightforward interpretation of $m/0 = \infty$ where the mass m divided by the radius $r = 0$ in particular. The intersections of lines which is connecting the points with the infinity point of the North Pole are ultimately interpreted to overlap the North Pole when the points at infinity extend infinitely on the complex two-dimensional plane. This situation, however, is considered a mere reiteration of "Infinity is infinity." because the behavior of extending to infinity is concluded with infinity. On the other hand, this situation can be interpreted with X which is the diameter of 1 as the distance from 0 to ∞ of the Riemann

sphere. The mass m does not come onto the center of gravity without annihilating of X through division by zero. Due to the unsolvable nature of this zero division problem, a solution using division by zero is considered either non-existent or infinitely large. Gravity therefore becomes infinitely large at zero distance, which has been demonstrated to result in contradiction and collapse at the level of Conservation of Energy, the first and second law of thermodynamics. We considered the hypothesis of the state of emergence and defined anti-0 [$0 \Rightarrow 1$] as a symbol that produces existence from nothing. We also geometrically derived the "converse" and "inverse" of the anti-Riemann sphere from the original Riemann sphere to resolve the zero division problem of the Einstein's relativity. Next, we defined anti- ∞ and anti- \emptyset , and derived that anti- $\infty = (0 \equiv \infty)$. Relating to the derivation, we have shown that joint of an Einstein field and an anti-Einstein

field become $(0 \equiv \infty) = 1$ by passing through the duality of zero. We called this the emergence axiom hypothesis. An anti-Riemann domain is considered using the converse and inverse Riemann spheres hypothetically. The terms converse, inverse and anti are defined as a theory, following which this logic is applied to derive an anti-Einstein field with a new means of operation. Ultimately, defining anti-0[0 \Rightarrow 1] as the symbol of emergence, the equation $(0 \equiv \infty) = 1$ is established by using the function that Mitsuyoshi operator. Thus, the operator ties the Quantum Theory and the Theory of Relativity.

By applying the Mitsuyoshi operator to confine time-scale of the equation $(0 \equiv \infty) = 1$, the equation $\Omega = (0 \equiv \infty) = 1$ (everything) is attained. Thus, this equation enables compression of the Riemann sphere diameter to zero and the calculation of zero distance. The Mitsuyoshi operator was used in the axiom hypothesis. The axiom hypothesis is that "when zero is equivalent to ∞ , the 1 emerges as the total energy of the universe." Further, we gave some ideas about infinity.

Based on the above, we show that quantum theory and the 0 Einstein field can be simply connected without contradiction by controlling "space-time," and that the entire universe has a structure of $(0 \equiv \infty) = 1$. This can be said to represent observing the universe from the outside, but it also suggests the possibility that the existence outside the universe was created by the emergence symbol anti-0. If that is true, it raises the issue of whether or not the region outside this universe is also a universe. In particular, the issue is whether or not an anti-universe is still a universe despite being an anti-universe, where the "anti" created by "converse" and "inverse" is analogous to antimatter.

It is necessary to prove the axiom hypothesis through physical experiments because this hypothesis is no more than a proposal. However, if these physics experiments are successful, the Mitsuyoshi operator will be used to "quantum gate" of a quantum computer.

12. Future research themes

- Imagining the converse-Riemann sphere as a "phase transition from a strained competition," anti- ∞ {0 \equiv ∞ } and anti-0 {0 \Rightarrow 1} become necessary. In the rational function necessary for the analysis of human thinking process, this suggests the presence of anti. By measuring it, we can explore the possibility of anti-0 {0 \Rightarrow 1} being the mathematics of creativity, and anti- ∞ {0 \equiv ∞ } being the mathematics of curiosity, sympathy, and tolerance from diversity.
- Simulating the Riemann in a few spherical projection patterns (there are conceivable ways of projecting the sphere other than A and B above, but as they turn into differentiations of infinite division as in the Mercator projection, they were omitted), in the anti-Einstein field, a process that makes 0 and infinity the same and a requirement for the emergence of presence (1) from absence (0) arise.
- This was explained in an engineering mechanism as a principle of phase transition. With this, axiom mathematics becomes interpretable from engineering as an actual mechanism.

- As a result, $1/0 =$ "infinity is nothing, and 1 arises from nothing" in the anti-Einstein field. This phenomenon is interpreted widely and generally in quantum mechanics.
- If the set described above is involved in the h equation (homeostasis) in a Mitsuyoshi operator, phase transitioning in a nested state, we can hope for applications for new interpretations of superstring theory, which arose from Professor Nambu's research, and Boltzmann thermodynamics. In this case, it has been pointed out that the two limiting edges AB of Mitsuyoshi operator's range (x+y) becomes an "uncertainty of infinitesimal derivatives," but this operator involves the dynamic states of h characteristics, including tense. In addition, calculation separates concept numbers and continuous quantities, so it frees physicists from uncertainty and infinitesimal problems, making it a tool (operator) that makes it possible to perform continuous and discrete calculations simultaneously and elegantly.
- This is secondary, but by using the Mitsuyoshi operator for $E=mc^2$, it may be possible to convert mass into energy waves.
- Consider the following physical expansions corresponding to the cardinality conditions of ∞ as control systems:
- In addition, we have a mathematical interest in what would happen to $\infty \div 0$ and $0 \div \infty$ with the simple condition of $(0 \equiv \infty)=1$. Here, considering the conditions for ∞ , we realize the following cardinality conditions of ∞ . The corresponding physical projection is also considered a control system.

- I. Infinity has cardinality.
- II. Natural number cardinality (\aleph_0), real number cardinality (\aleph_1)
- III. $\aleph_1 = 2^{\aleph_0}$, $\aleph_0 \neq \aleph_1$
- IV. $\aleph_1 + \aleph_1 + \aleph_1 + \dots = \aleph_1$
- V. $\aleph_0 \times \aleph_0 \times \aleph_0 \times \dots = \aleph_1$
- VI. $\aleph_0 + \aleph_0 + \aleph_0 + \dots = \aleph_0$

13. Acknowledgments

We would like to thank Dr.Shuji Shinohara, Dr.Yasuto Tanaka and Mr.Masahiko Nemoto for useful discussions. We would like, also, to thank Mr.Masayoshi Son and Mr.Fumihide Tomizawa for considering AE(Artificial Ego) commercialization. This work was supported by SoftBank Robotics Corp. and Japan Tobacco Inc.

[Bibliographies]

- [1] A. Einstein, "Über den Einfluß der Schwerkraft auf die Ausbreitung des Lichtes", (German) (PDF). *Annalen der Physik (Leipzig)* 340 (10). 898-908. Bibcode 1911AnP.340.898E. doi:10.1002/andp.19113401005. ISSN 0003-3804. OCLC 5854993. June 21, (1911).
- [2] A. Einstein, "Die Grundlage der allgemeinen Relativitätstheorie", (German) (PDF). *Annalen der Physik (Leipzig)* 354 (7). 769-822. Bibcode 1916AnP.354.769 E. doi:10.1002/andp.19163540702. ISSN 0003-3804. OCLC 5854993. March 20, (1916).
- [3] R. Penrose, and W. Rindler, "Spinor and Space Time: Vol. 1, Two-Spinor. Calculus and Relativistic Fields", *Cambridge Monographs on Mathematical. Physics*, Cambridge, (1984).
- [4] L.V.Ahlfors, "Complex Analysis", Mc Graw Hill, 1953, Third Edition (ISBN 978-007-085008-8), (1979).
- [5] S. Mitsuyoshi, "Research on the phonetic recognition of feelings and a system for emotional physiological brain signal analysis" (Japan), Tokushima University, 2006, Doctoral dissertation, (2006).
- [6] Stephen W. Hawking, "The Theory of Everything", The Origin and Fate of the Universe. Phoenix Books; Special Anniv. ISBN 978-1-59777-508-3. (28 February 2006).
- [7] W. Heisenberg, "Über quantentheoretische Umdeutung kinematischer und mechanischer Beziehungen", *Zeitschrift für Physik* 33, pp. 879-893, (1925).
- [8] E. Schrodinger, "Quantisierung als Eigenwertproblem I", *Annalen der Physik* 79, pp. 361-376, (1926).
- [9] Y. Nambu and G. Jona-Lasinio, "Dynamical model of elementary particles based on an analogy with superconductivity. I.", *Phys. Rev.* 122, pp. 345-358, (1961).
- [10] P.A.M. Dirac, "The Quantum Theory of the Electron", *Proc. R. Soc. A* 117 (778), pp. 610-624, doi: 10.1098 /rspa.1928.0023, (1928).
- [11] C. D. Anderson, "The Apparent Existence of Easily Deflectable Positives", *Science, New Series*, vol.76, no.1967, pp.238-239, (1932).
- [12] N. Alling, and N. Greenleaf, "Klein surfaces and real algebraic function fields", *Bulletin of the American Mathematical*, soc.75, pp.869-872, (1969).
- [13] Banks, Tom, Fischler, Willy, "Shenker, Stephen H. Susskind, Leonard "M theory as a matrix model: A conjecture". *Physical Review D* 55 (8), doi:10.1103/PhysRevD.55.5112.arXiv:hep-th/9610043 pp.5112-5128, (1997).

【論文】

反アインシュタイン場仮説

光吉 俊二¹・朝長 康介²・橋本 昌嗣³・鄭 雄一⁴・中村 維男⁵

(¹東京大学大学院工学系研究科 特任准教授・²東京大学大学院工学系研究科 共同研究員・³デジタルハリウッド大学大学院 デジタルコンテンツ研究科 客員教授・⁴東京大学大学院工学系研究科・医学系研究科(兼任)教授・⁵東北大学 名誉教授)

Einsteinの相対性理論において、Riemann球体面による二次元的な複素数平面上の点を、三次元的な球体の上へ写像させるアイデアに基づく立体写像での解釈が広く一般的に知られている。また、ゼロ除算において、 $1/0=\infty$ とされる説明にもよく使われている。これはRiemann球体面の北極点に無限遠点が無限に伸びると球面上の無限遠点と北極点を結ぶ線との交点が北極点に重なることで解釈される。しかし、これは「無限の行為を無限である」と説明しているだけではないのかとも考えられる。そこで論理学としての「逆」「裏」「反」を新規に定義し、これによる逆Riemann球体と裏Riemann球体を想定し、そこで、新規演算子を使い反Einstein場の仮説を立てた。

キーワード：相対性理論、Riemann球体、量子論、対生成、クラインの壺、自発対称性の破れ、光吉演算子